

LD155

HIGH-POWER ADJUSTABLE INTERIOR/ EXTERIOR RECESSED LED UPLIGHT

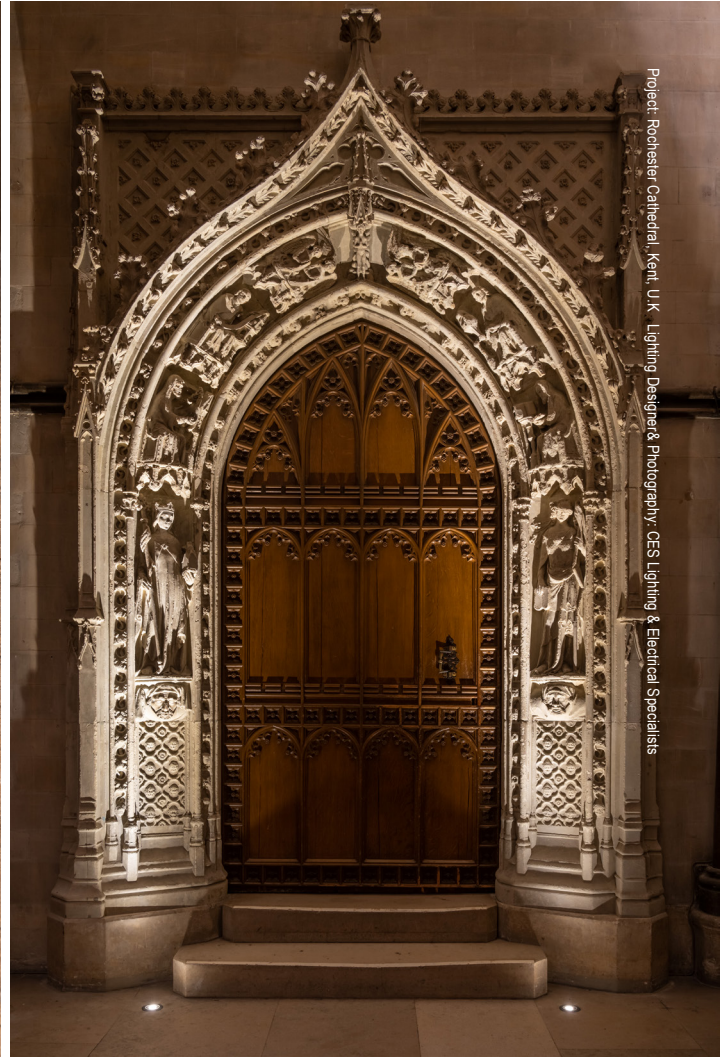

The LD155 is a high powered, adjustable uplight with an innovative 360° rotating ball joint containing the LED, optics and accessories, which can be tilted at set increments up to 25°. On-site focusing is achieved quickly with a detachable inner bezel, eliminating the need for the product to be removed from the mounting surface. This product can be specified with a wide range of options allowing it to suit many project requirements including multiple bezel finishes to choose from. The bezel is minimal with toughened, black trim glass and an optional honeycomb louvre can be specified to further reduce glare. LD155 offers a choice of powerful E3, N1 and F1 LED engines with outputs up to 900lm, colour temperatures between 2200K-5000K and excellent CRIs of 90+ (when choosing N1/F1). This is a unique product that was designed specifically to provide lighting designers with a powerful uplight solution that ensures excellent thermal and light output performance and the ability to make easy adjustments to the beam position on-site.



Project: Rochester Cathedral, Kent, UK. Lighting Designer & Photography: CSS Lighting & Electrical Specialists

KEY FEATURES

- > Removable inner bezel for quick on-site focusing with 3D printed tool that allows fine adjustment of the tilt angle at set increments up to 25°
- > Innovative ball joint design with multi-directional 360° rotation
- > Interchangeable optics and accessories including a honeycomb louvre
- > E3 LED engine, with NICHIA LED delivering up to 583 lumens at 700mA in 3000K with built-in reverse polarity protection
- > N1 LED engine options, producing up to 853 lumens at 700mA in 3000K
- > Compact design with excellent thermal management and light output performance in temperatures up to 45° (500mA)
- > Bezel available in 316 Stainless Steel, Polished & Passivated 316 Stainless Steel and RAL paint finishes
- > Single light source and optic produces a very consistent beam, no multiple shadows
- > Toughened glass with black ceramic trim
- > Fitting rated IK08
- > Switched, 0-10V, Casambi, DMX, DALI, or Mains dimmable drivers available





DIMENSIONS

Dimensions in mm

For full dimensions please go to page 4.



SPECIFICATION

Engine	 E3			 N1			 F1		
Beam angles	12°, 19°, 34°, 54°, 15°x 49°			25°, 35°, 46°, 65°, 22°x 43°			25°, 46°, 65°, 18°x 45°		
LED manufacturer	NICHIA			CREE			CREE		
Colour temperature	2700K / 3000K / 4000K / 5000K			2200K / 2700K / 3000K / 4000K / 5000K			2200K		
Current	350mA	500mA	700mA	350mA	500mA	700mA	350mA	500mA	700mA
LED power (Max)	4.2W (5W**)	6W (7W**)	8.4W (10W**)	6.6W (7W**)	9.4W (10W**)	13.3W (14W**)	3.2W (3.5W**)	4.5W (5W**)	6.3W (7W**)
Delivered lumens (L ₁₀₀)*	337	458	583	467	638	853	247	323	383
Lumens per circuit watt	67	65	58	67	64	61	71	65	56
CRI (Typ)	85			93			90		
Forward voltage (V ₁₀₀)	14V			18V			9V		
Colour consistency	2 SCDM			2 SCDM			3 SCDM		
Peak intensity	5780 cd			2974 cd			1706 cd		
LED Lumens	840			1393			623		
LOR	0.69			0.62			0.61		
TM30	RF86	RG99		RF91	RF91		RF90	RG103	
LED lifetime	L90B5 at 90,000hrs								
UGR	10.5								
Applications									

These values are based around a LD155-E3-700-LW30-NB, LD155 -N1-700-LW30-MSB & LD155 -F1-700-LW22-MSB

*Lumen output data applies to all colour temperatures

**indicates the nominal power for the LED run at that particular current and includes losses associated with using an 85% efficient driver

MECHANICAL

Ambient temperature	-20° to 45° (500mA) or -20° to 35° (700mA)
Glass	Toughened glass with black ceramic screen print, 6mm thick
Materials	Black anodised aluminium body, machine finished 316 Stainless Steel bezel (other options available)
Wiring	Constant current wiring
Weight of product	1.3kg
IP rating	IP67
IK rating	IK08
Wiring	In-series constant current wiring (pre-wired with 2 core cable at 250mm)

ENVIRONMENTAL

TM65	Available on request
TM66	2.5

AVAILABLE FINISHES

Please refer to our finishes guide for full details



316 STAINLESS STEEL

- > Marine grade 316 Stainless Steel
- > Standard machined finish
- > Extremely durable
- > Passivation recommended for marine environments to prevent corrosion and build up of brown stains caused by oxidation
- > Interior & exterior use



POLISHED & PASSIVATED 316 STAINLESS STEEL

- > Marine Grade 316 Stainless Steel
- > Pristine mirror like finish
- > Recommended for pools and marine applications
- > Extremely durable with very high corrosion resistance
- > Passivated to extensively prolong resistance to corrosion and brown stains caused by oxidation in marine environments
- > Interior & exterior use



WHITE (RAL 9016)



BLACK (RAL 9005)



CLASSIC BRONZE (YM262E)



TEXTURED MARS BRONZE



TEXTURED FIR GREEN (RAL 6009)



GUNMETAL GREY (RAL 7021)



RAL

PAINT FINISH - POWDER COAT

- > The powder coated finish is very matt
- > Not recommended for high traffic in-ground applications, unless placed to one side where the bezel will not be walked on
- > Powder coat paint is generally used on stainless steel or anodised aluminium components
- > Interior and exterior use

ADJUSTABILITY

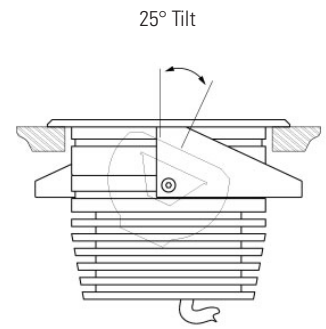
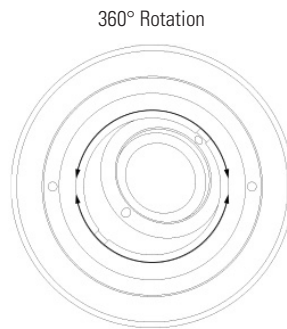
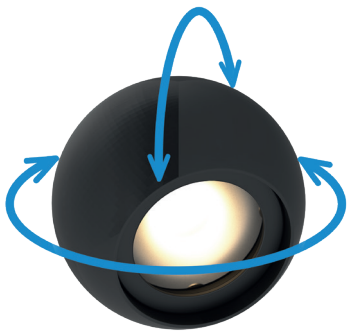

FIXING OPTIONS & DIMENSIONS

Dimensions in mm

/SC Spring Clips

Suitable for use in surfaces with a thickness of 1mm – 25mm. Spring clips can provide a simple, single fix mounting method. We recommend that spring clips are only used in interior applications.

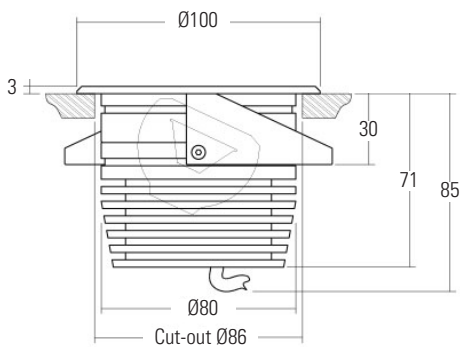

/485S Fixing Sleeve and O-rings

Acetal sleeve is bonded into the mounting surface first and the fitting is held in with O-rings. We recommend this method for mounting in exterior in-ground applications.

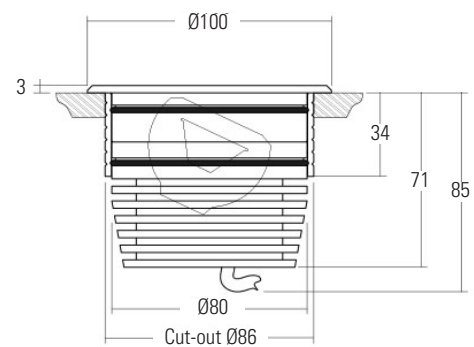

/485N or /485N-2 Concrete Housing

The aluminium housing is used as a heat sink which keeps the LED fitting cool through the thermal transfer of the heat within the housing to the surrounding concrete. The housings are big enough for IP rated connections to be made inside and a second gland is available for cabling onto the next luminaire.

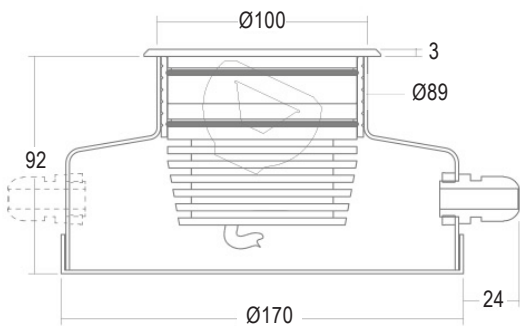

/485N
Concrete housing with 1x PG9 IP67 gland



/485N-2
Concrete housing with 2x PG9 IP67 gland

ACCESSORIES AND GLARE SHIELD OPTIONS

/HT155 Hand tool

The HT155 hand tool is required to open and adjust the LD155. This tool is unique to the LD155, allowing you to open the bezel, rotate and angle the LED module into the desired position for quick onsite focusing. Angle adjustments are made either freehand, or with the supplied angle guide, working in increments of 2.5° (from 0° up to 25°). The hand tool is completely plastic to prevent accidental scratches when opening and making adjustments. If commissioning a large group, then more than one tool may be required to allow multiple people to make adjustments at the same time. Tool is supplied separately and will be automatically quoted.

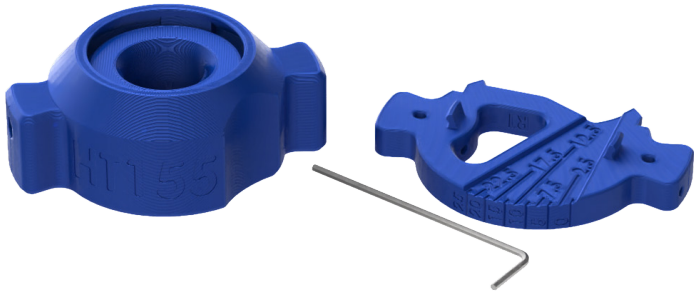

/HL Honeycomb louvre

The honeycomb louvre can be added after installation and helps prevent glare from all angles.



HOW TO USE THE HAND TOOL

- 1 Pull apart the top half of the HT155 and fit into the corresponding holes on the top of the fitting. Press palm down on top of the tool, grip, and begin to unscrew the inner bezel.

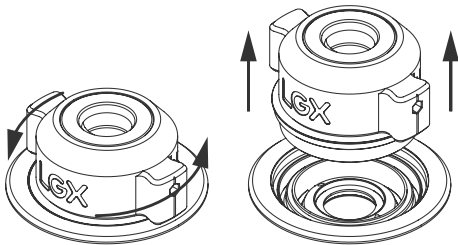

- 3 Always start in the level & upright position. Push towards the desired lit surface. If you overshoot, bring the LED back to the starting position before tilting again.

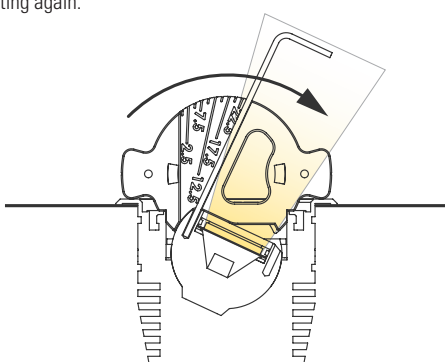

- 2 The LED can now either be focussed by hand, or by using the tool supplied. Place the LED angle adjustment tool inside the fitting, along with the provided allen key.

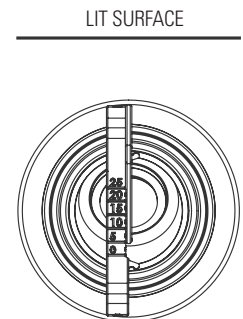
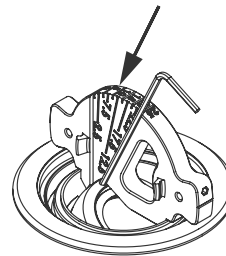

- 4 Make sure inner bezel is clean before refitting. Ensure inner bezel is flush with the outer bezel.

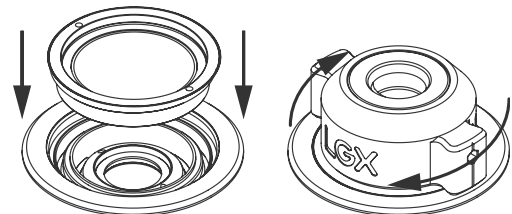

CONE DIAGRAMS

E3 LED Engine

Cone diagrams below are based on a 3000K E3 LED engine run at maximum output 700mA, 10W. Images below represent beam outputs when wall washing a 3m wall, spaced 125mm away from the lit surface. Photometric files (LDT) are included in the design pack which can be downloaded from the LD155 product page on the website.

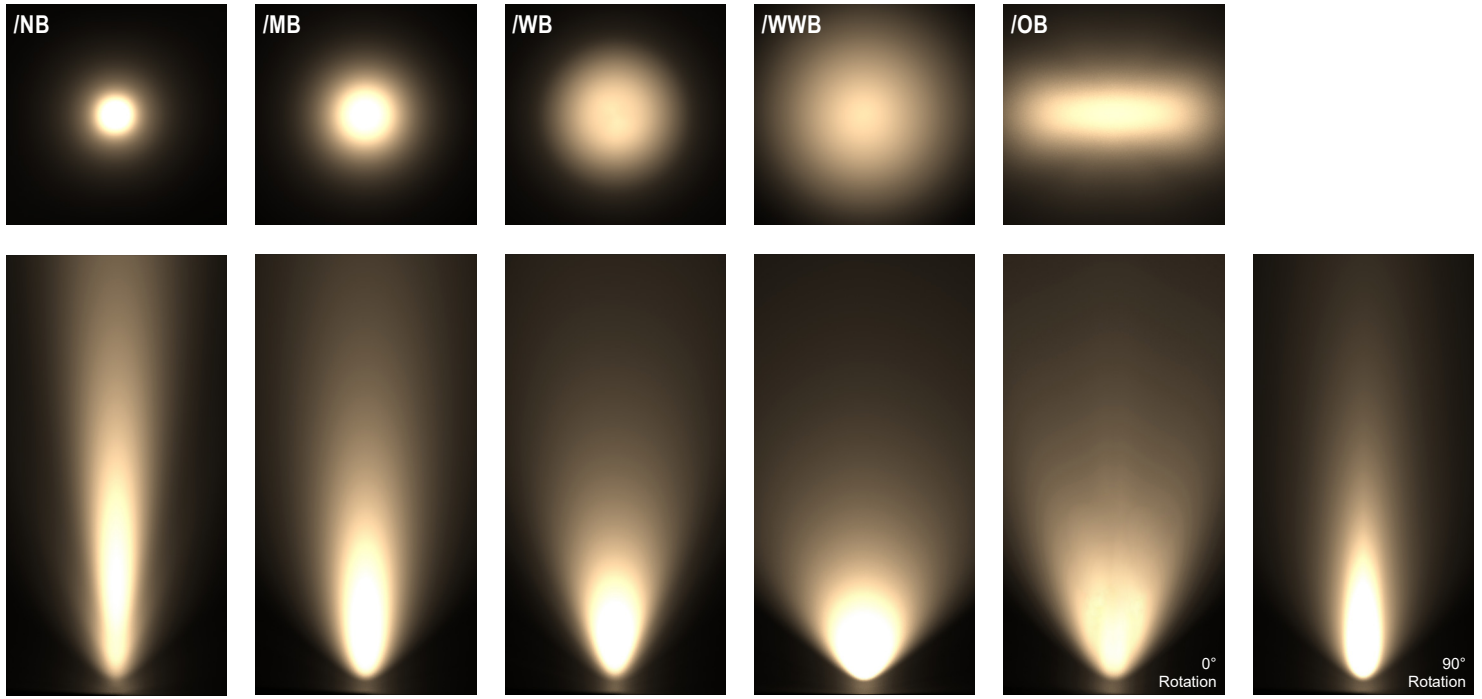

Narrow Beam
700mA using a 12° optic

Distance (m)	Cone Width (m)	Luminance (lx)
3.0	0.77	579
2.5	0.64	834
2.0	0.51	1304
1.5	0.38	2318
1.0	0.26	5215
0.5	0.13	20860

Medium Beam
700mA using a 19° optic

Distance (m)	Cone Width (m)	Luminance (lx)
3.0	1.00	345
2.5	0.84	496
2.0	0.67	776
1.5	0.50	1379
1.0	0.33	3102
0.5	0.17	12409

Wide Beam
700mA using a 34° optic

Distance (m)	Cone Width (m)	Luminance (lx)
3.0	1.63	146
2.5	1.36	210
2.0	1.09	329
1.5	0.82	584
1.0	0.54	1315
0.5	0.27	5260

Extra Wide Beam
700mA using a 54° optic

Distance (m)	Cone Width (m)	Luminance (lx)
3.0	3.07	65
2.5	2.56	93
2.0	2.05	146
1.5	1.54	206
1.0	1.02	584
0.5	0.51	2336

Oval Beam
700mA using a 15° X 49° optic

Distance (m)	Cone Width (m)	Luminance (lx)
3.0	2.42 / 0.72	239
2.5	2.02 / 0.60	345
2.0	1.62 / 0.48	539
1.5	1.21 / 0.36	958
1.0	0.81 / 0.24	2155
0.5	0.40 / 0.12	8621

N1 LED Engine

Cone diagrams below are based on a 3000K N1 LED engine run at maximum output 700mA, 14W. Images below represent beam outputs when wall washing a 3m wall, spaced 125mm away from the lit surface. Photometric files (LDT) are included in the design pack which can be downloaded from the LD155 product page on the website.

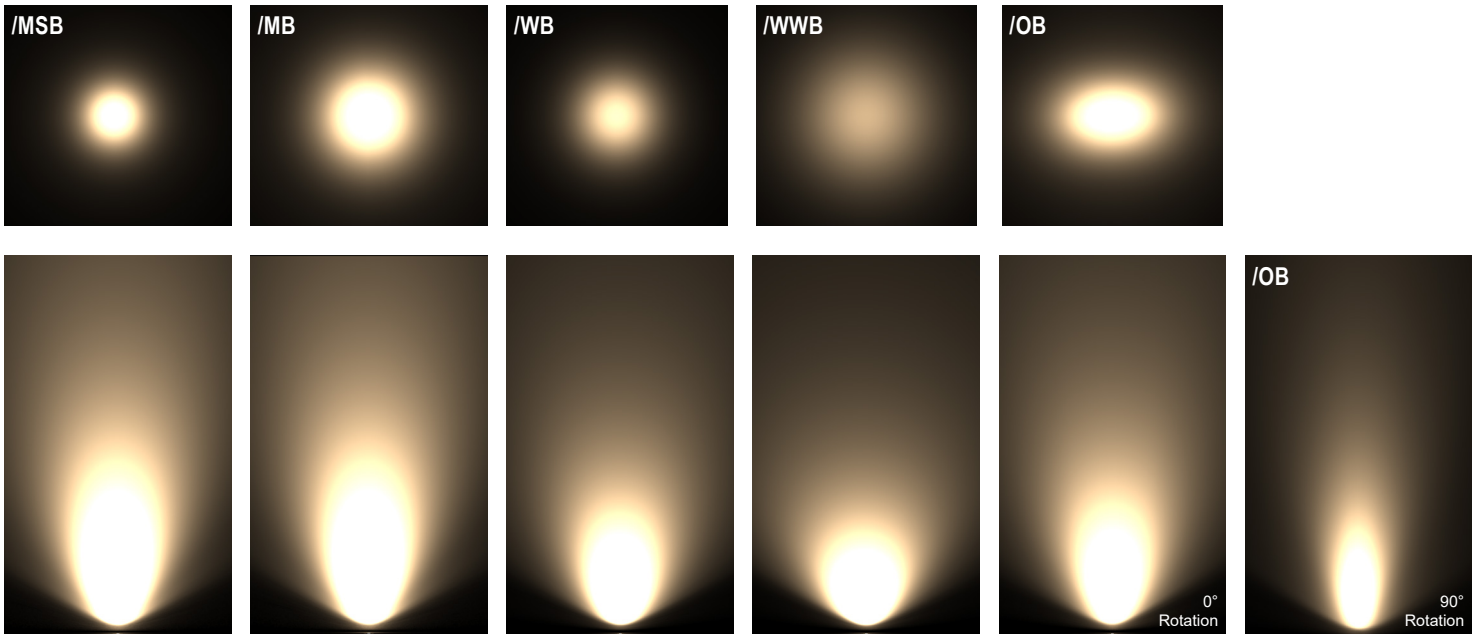

Medium Spot Beam
700mA using a 25° optic

Distance (m)	Luminance (lx)	
3.0	1.41	326
2.5	1.17	470
2.0	0.94	734
1.5	0.70	1305
1.0	0.47	2937
0.5	0.23	11748

Cone Width (m)

Medium Beam
700mA using a 35° optic

Distance (m)	Luminance (lx)	
3.0	1.81	233
2.5	1.51	336
2.0	1.21	525
1.5	0.91	934
1.0	0.60	2101
0.5	0.30	8402

Cone Width (m)

Wide Beam
700mA using a 46° optic

Distance (m)	Luminance (lx)	
3.0	2.42	146
2.5	2.02	210
2.0	1.62	328
1.5	1.21	583
1.0	0.81	1312
0.5	0.40	5248

Cone Width (m)

Extra Wide Beam
700mA using a 65° optic

Distance (m)	Luminance (lx)	
3.0	3.65	84
2.5	3.04	121
2.0	2.43	189
1.5	1.82	336
1.0	1.22	755
0.5	0.61	3020

Cone Width (m)

Oval Beam
700mA using a 22° x 43° optic

Distance (m)	Luminance (lx)	
3.0	2.33 / 1.30	225
2.5	1.94 / 1.08	323
2.0	1.55 / 0.86	505
1.5	1.16 / 0.65	898
1.0	0.78 / 0.43	2021
0.5	0.39 / 0.22	8082

Cone Width (m)

F1 LED Engine

Cone diagrams below are based on a 2200K F1 LED engine run at maximum output 700mA, 7W. Images below represent beam outputs when wall washing a 3m wall, spaced 125mm away from the lit surface. Photometric files (LDT) are included in the design pack which can be downloaded from the LD155 product page on the website.

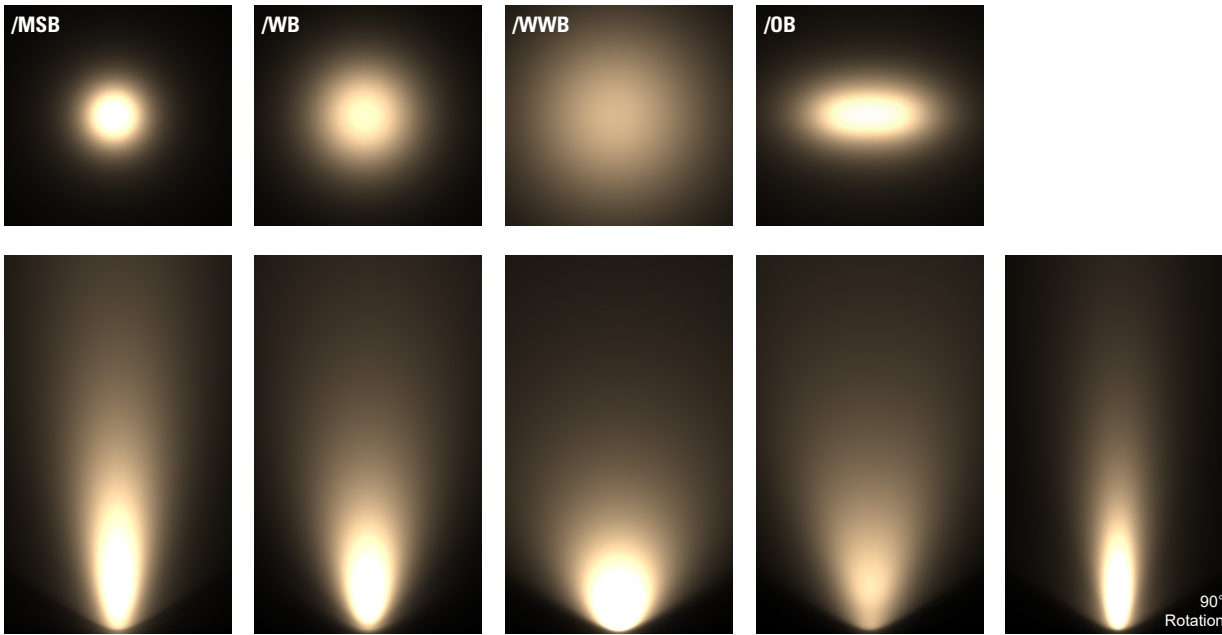

Medium Spot Beam
700mA using a 25° optic

Distance (m)	Cone Width (m)	Luminance (lx)
3.0	1.18	200
2.5	0.98	288
2.0	0.78	450
1.5	0.59	801
1.0	0.39	1802
0.5	0.20	7206

Wide Beam
700mA using a 46° optic

Distance (m)	Cone Width (m)	Luminance (lx)
3.0	1.65	97
2.5	1.38	140
2.0	1.10	219
1.5	0.83	389
1.0	0.55	875
0.5	0.28	3499

Extra Wide Beam
700mA using a 65° optic

Distance (m)	Cone Width (m)	Luminance (lx)
3.0	3.30	44
2.5	2.75	64
2.0	2.20	100
1.5	1.65	177
1.0	1.10	399
0.5	0.55	1597

Oval Beam
700mA using a 18° X 45° optic

Distance (m)	Cone Width (m)	Luminance (lx)
3.0	1.98 / 0.98	144
2.5	1.65 / 0.82	207
2.0	1.32 / 0.66	324
1.5	0.99 / 0.49	576
1.0	0.66 / 0.33	1295
0.5	0.33 / 0.16	5181

INSTALLATION GUIDE

Below is a luminaire positioning guide for white LEDs. Every project and lighting scenario will be different; the table below is to be used as a starting point for any wall wash design. Please use our photometric files to further test the desired effect for your application. Files are available on our LD155 product page on our website.

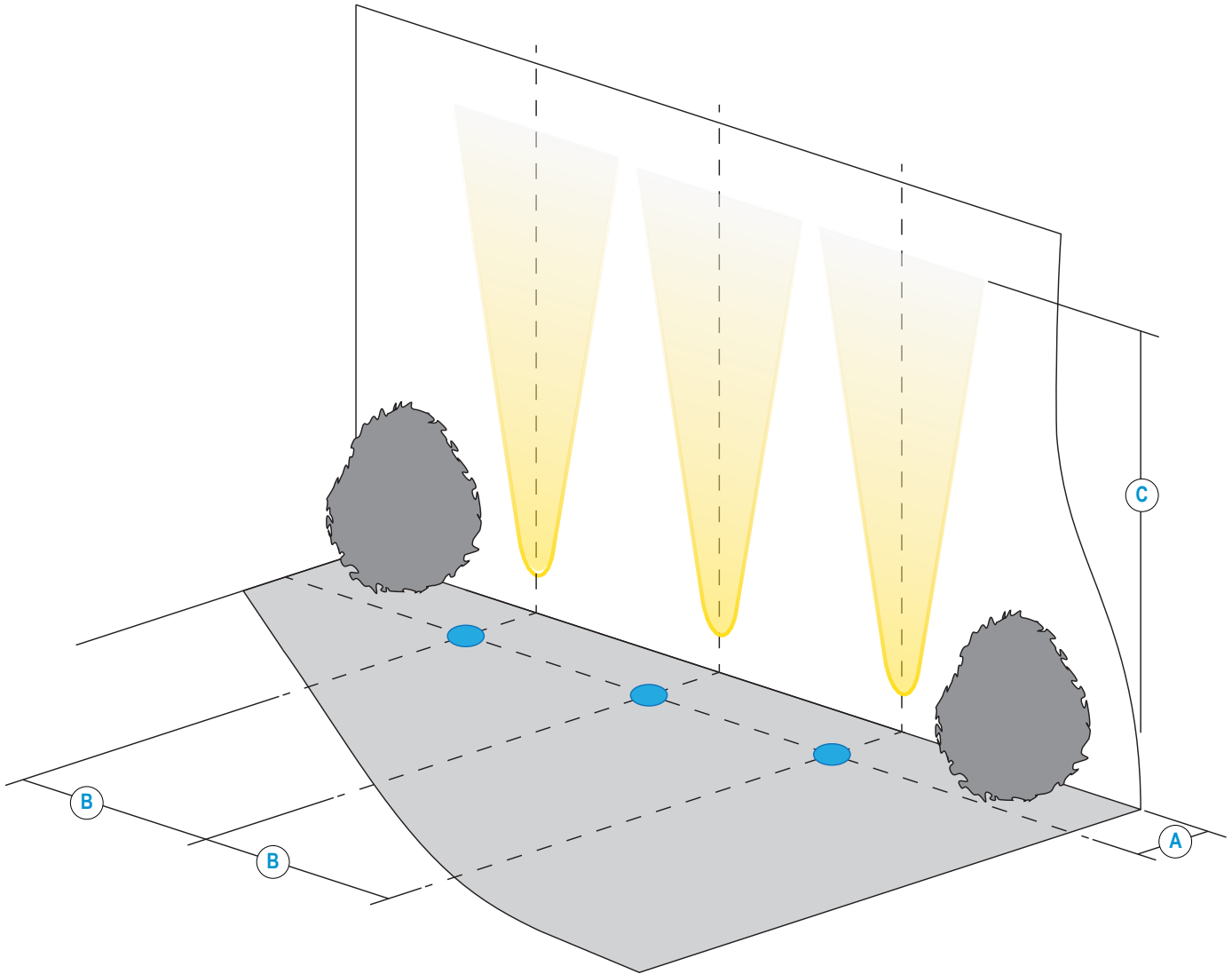

LD155-E3	/NB	/MB	/WB	/WWB	/OB
A Distance from the centre of the fitting to the lit surface	125mm				
B Spacing for an even wash	250mm*	350mm	400mm	500mm	500mm
C 700mA Lit distance	20m	18m	8m	8m	13m

*Wall washing using narrow beam optics should only be used if the designer requires long distance lighting up the lit surface.

LD155-N1	/MSB	/MB	/WB	/WWB	/OB
A Distance from the centre of the fitting to the lit surface	250mm				
B Spacing for an even wash	250mm*	500mm	750mm	1000mm	750mm
C 700mA Lit distance	27m	22m	17m	14m	21m

*Wall washing using narrow beam optics should only be used if the designer requires long distance lighting up the lit surface.

LD155-F1	/MSB	/WB	/WWB	/OB
A Distance from the centre of the fitting to the lit surface	125mm			
B Spacing for an even wash	350mm	400mm	500mm	500mm
C 700mA Lit distance	5m	4m	2m	4m

INSTALLATION REQUIREMENTS

Installation requirements can vary but the minimum installation volume requirements must be adhered to. The volume of air or concrete is to ensure that the thermal performance of the product is not compromised and ensures the proper cooling of the LED. The minimum recess depth is 85mm. The volumes below are presented as L x W x H.

Mounting in surface with air void underneath - /SC Spring Clip and /485S Sleeve

If installing into a surface where there will be air around the base of the fitting, these are the minimum space requirements around the fixture. For example, a floating floor. The fixture can be installed into a solid floor but the minimum air volume requirements need to be adhered to.

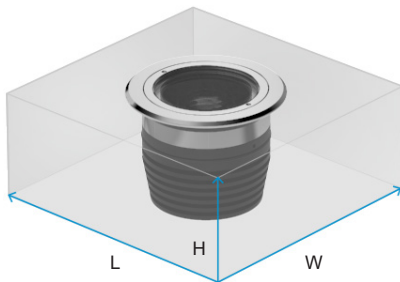

Mounting into solid concrete with the 485N Concrete Housing

Concrete is great for absorbing heat so the LD155 with the concrete housing performs excellently. The below figures detail the minimum volume of concrete that should be used around the housing. This is not an issue if installed into a concrete floor, but can be if the housing is being used in lawn or soil applications where the housing is fixed at the base with a small amount of concrete.

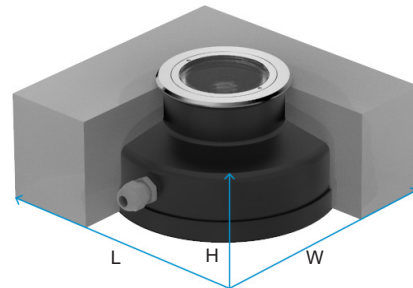

E3/F1 LED			
Output current	Minimum void dimension requirements (Lmm x Wmm x Hmm)	Minimum void volume	
		cm ³	Litre(s)
LD155-E3-350	120 x 120 x 85	1,200cm ³	1.2
LD155-E3-500	160 x 160 x 85	2,200cm ³	2.2
LD155-E3-700	220 x 220 x 85	4,000cm ³	4.0

E3/F1 LED			
Output current	Minimum void dimension requirements (Lmm x Wmm x Hmm)	Minimum volume of concrete	
		cm ³	Litre(s)
LD155-E3-350	300 x 300 x 180	18000cm ³	18
LD155-E3-500			
LD155-E3-700	400 x 400 x 200	32000cm ³	32











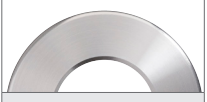













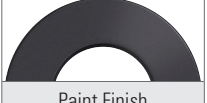





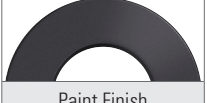

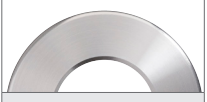













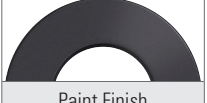





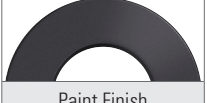

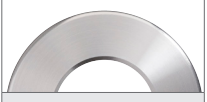









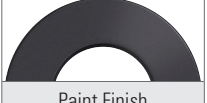

N1 LED			
Output current	Minimum void dimension requirements (Lmm x Wmm x Hmm)	Minimum void volume	
		cm ³	Litre(s)
LD155-N1-350	150 x 150 x 85	1,900cm ³	1.9
LD155-N1-500	180 x 180 x 85	2,700cm ³	2.7
LD155-N1-700*	240 x 240 x 85	4,900cm ³	4.9

N1 LED			
Output current	Minimum void dimension requirements (Lmm x Wmm x Hmm)	Minimum volume of concrete	
		cm ³	Litre(s)
LD155-N1-350	300 x 300 x 180	18000cm ³	18
LD155-N1-500			
LD155-N1-700	400 x 400 x 200	32000cm ³	32

* Max 25°C ambient

ORDER CODES & OPTIONS

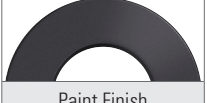
Example: LD155-E3-700 / LW30 / MB / 316 STAINLESS STEEL / SC / HL

Light Engine & Drive Current		LED Colour		Beam Angle		Finish		Fixing & Accessories																																																																																																																																													
LD155 -																																																																																																																																																					
<div style="display: flex; justify-content: space-between;"> <div style="width: 20%;"> <p>E3</p> <table border="1"> <tr> <td>5W LED at 350mA</td> <td>LD155-E3-350</td> <td>Extra Warm White (2700K)</td> <td>/LW27</td> <td>12° Narrow spot</td> <td>/NB</td> <td></td> <td>316 Stainless Steel</td> <td></td> <td>/SC</td> </tr> <tr> <td>7W LED at 500mA</td> <td>LD155-E3-500</td> <td>Warm White (3000K)</td> <td>/LW30</td> <td>19° Medium</td> <td>/MB</td> <td></td> <td>Polished & Passivated 316 Stainless Steel (for marine environments)</td> <td></td> <td>/485S</td> </tr> <tr> <td>10W LED at 700mA</td> <td>LD155-E3-700</td> <td>White (4000K) - on request</td> <td>/LW40</td> <td>34° Wide</td> <td>/WB</td> <td></td> <td>Paint Finish White (RAL 9016)</td> <td></td> <td>/485N</td> </tr> <tr> <td></td> <td></td> <td>Cool White (5000K)</td> <td>/LW50</td> <td>54° Extra wide</td> <td>/WWB</td> <td></td> <td>Paint Finish Black (RAL 9005)</td> <td></td> <td>/485N-2</td> </tr> <tr> <td></td> <td></td> <td></td> <td></td> <td>15° x 49° Oval</td> <td>/OB</td> <td></td> <td>Paint Finish Classic Bronze (YM262E)</td> <td></td> <td>/HL</td> </tr> </table> </div> <div style="width: 20%;"> <p>N1</p> <table border="1"> <tr> <td>7W LED at 350mA</td> <td>LD155-N1-350</td> <td>Super Warm White (2200K)</td> <td>/LW22</td> <td>25° Medium spot</td> <td>/MSB</td> <td></td> <td>Paint Finish White (RAL 9016)</td> <td></td> <td>/485N</td> </tr> <tr> <td>10W LED at 500mA</td> <td>LD155-N1-500</td> <td>Extra Warm White (2700K)</td> <td>/LW27</td> <td>35° Medium</td> <td>/MB</td> <td></td> <td>Paint Finish Black (RAL 9005)</td> <td></td> <td>/485N-2</td> </tr> <tr> <td>14W LED at 700mA</td> <td>LD155-N1-700</td> <td>Warm White (3000K)</td> <td>/LW30</td> <td>46° Wide</td> <td>/WB</td> <td></td> <td>Paint Finish Classic Bronze (YM262E)</td> <td></td> <td>/HL</td> </tr> <tr> <td></td> <td></td> <td>White (4000K) - on request</td> <td>/LW40</td> <td>65° Extra wide</td> <td>/WWB</td> <td></td> <td>Paint Finish Textured Mars Bronze</td> <td></td> <td></td> </tr> <tr> <td></td> <td></td> <td>Cool White (5000K)</td> <td>/LW50</td> <td>22° x 43° Oval</td> <td>/OB</td> <td></td> <td>Paint Finish Textured Fir Green (RAL 6009)</td> <td></td> <td></td> </tr> </table> </div> <div style="width: 20%;"> <p>F1</p> <table border="1"> <tr> <td>3.5W LED at 350mA</td> <td>LD155-F1-350</td> <td>Super Warm White (2200K)</td> <td>/LW22</td> <td>25° Medium spot</td> <td>/MSB</td> <td></td> <td>Paint Finish Textured Mars Bronze</td> <td></td> <td></td> </tr> <tr> <td>5W LED at 500mA</td> <td>LD155-F1-500</td> <td></td> <td></td> <td>46° Wide</td> <td>/WB</td> <td></td> <td>Paint Finish Textured Fir Green (RAL 6009)</td> <td></td> <td></td> </tr> <tr> <td>7W LED at 700mA</td> <td>LD155-F1-700</td> <td></td> <td></td> <td>65° Extra wide</td> <td>/WWB</td> <td></td> <td>Paint Finish Gunmetal Grey (RAL 7021)</td> <td></td> <td></td> </tr> <tr> <td></td> <td></td> <td></td> <td></td> <td>18° x 45° Oval</td> <td>/OB</td> <td></td> <td>Paint Finish - RAL</td> <td></td> <td></td> </tr> </table> </div> </div>										5W LED at 350mA	LD155-E3-350	Extra Warm White (2700K)	/LW27	12° Narrow spot	/NB		316 Stainless Steel		/SC	7W LED at 500mA	LD155-E3-500	Warm White (3000K)	/LW30	19° Medium	/MB		Polished & Passivated 316 Stainless Steel (for marine environments)		/485S	10W LED at 700mA	LD155-E3-700	White (4000K) - on request	/LW40	34° Wide	/WB		Paint Finish White (RAL 9016)		/485N			Cool White (5000K)	/LW50	54° Extra wide	/WWB		Paint Finish Black (RAL 9005)		/485N-2					15° x 49° Oval	/OB		Paint Finish Classic Bronze (YM262E)		/HL	7W LED at 350mA	LD155-N1-350	Super Warm White (2200K)	/LW22	25° Medium spot	/MSB		Paint Finish White (RAL 9016)		/485N	10W LED at 500mA	LD155-N1-500	Extra Warm White (2700K)	/LW27	35° Medium	/MB		Paint Finish Black (RAL 9005)		/485N-2	14W LED at 700mA	LD155-N1-700	Warm White (3000K)	/LW30	46° Wide	/WB		Paint Finish Classic Bronze (YM262E)		/HL			White (4000K) - on request	/LW40	65° Extra wide	/WWB		Paint Finish Textured Mars Bronze					Cool White (5000K)	/LW50	22° x 43° Oval	/OB		Paint Finish Textured Fir Green (RAL 6009)			3.5W LED at 350mA	LD155-F1-350	Super Warm White (2200K)	/LW22	25° Medium spot	/MSB		Paint Finish Textured Mars Bronze			5W LED at 500mA	LD155-F1-500			46° Wide	/WB		Paint Finish Textured Fir Green (RAL 6009)			7W LED at 700mA	LD155-F1-700			65° Extra wide	/WWB		Paint Finish Gunmetal Grey (RAL 7021)							18° x 45° Oval	/OB		Paint Finish - RAL		
5W LED at 350mA	LD155-E3-350	Extra Warm White (2700K)	/LW27	12° Narrow spot	/NB		316 Stainless Steel		/SC																																																																																																																																												
7W LED at 500mA	LD155-E3-500	Warm White (3000K)	/LW30	19° Medium	/MB		Polished & Passivated 316 Stainless Steel (for marine environments)		/485S																																																																																																																																												
10W LED at 700mA	LD155-E3-700	White (4000K) - on request	/LW40	34° Wide	/WB		Paint Finish White (RAL 9016)		/485N																																																																																																																																												
		Cool White (5000K)	/LW50	54° Extra wide	/WWB		Paint Finish Black (RAL 9005)		/485N-2																																																																																																																																												
				15° x 49° Oval	/OB		Paint Finish Classic Bronze (YM262E)		/HL																																																																																																																																												
7W LED at 350mA	LD155-N1-350	Super Warm White (2200K)	/LW22	25° Medium spot	/MSB		Paint Finish White (RAL 9016)		/485N																																																																																																																																												
10W LED at 500mA	LD155-N1-500	Extra Warm White (2700K)	/LW27	35° Medium	/MB		Paint Finish Black (RAL 9005)		/485N-2																																																																																																																																												
14W LED at 700mA	LD155-N1-700	Warm White (3000K)	/LW30	46° Wide	/WB		Paint Finish Classic Bronze (YM262E)		/HL																																																																																																																																												
		White (4000K) - on request	/LW40	65° Extra wide	/WWB		Paint Finish Textured Mars Bronze																																																																																																																																														
		Cool White (5000K)	/LW50	22° x 43° Oval	/OB		Paint Finish Textured Fir Green (RAL 6009)																																																																																																																																														
3.5W LED at 350mA	LD155-F1-350	Super Warm White (2200K)	/LW22	25° Medium spot	/MSB		Paint Finish Textured Mars Bronze																																																																																																																																														
5W LED at 500mA	LD155-F1-500			46° Wide	/WB		Paint Finish Textured Fir Green (RAL 6009)																																																																																																																																														
7W LED at 700mA	LD155-F1-700			65° Extra wide	/WWB		Paint Finish Gunmetal Grey (RAL 7021)																																																																																																																																														
				18° x 45° Oval	/OB		Paint Finish - RAL																																																																																																																																														

Drivers

Use with 350mA, 500mA & 700mA constant current LED drivers

We have a range of dimmable LED drivers DMX and DALI compatible. Please see the downloads section on our website.