

LD43/W/A/R/AR

LOW GLARE MINIATURE RECESSED INTERIOR/EXTERIOR LED UPLIGHT



The LD43 fittings are a range of miniature recessed uplights with a very minimal depth and small cables, ideal for interior applications, including bathrooms. Featuring a flush glass and walkover bezel for in-ground use, the LED and optics are recessed 10mm into the body for low glare. Various glare shield and tilt film options (W, A, R, AR) are also available for glare reduction and to create lit effects to suit individual applications. This includes aperture reductions of 50% or 70%, with or without an integral 20° tilt film, which focuses the light onto the lit surface for a concentrated lit effect. For a miniature fitting, LD43 produces an excellent throw of light when more output is required. If used with our LD42 wall light, a uniform floor and wall washing effect can be achieved.

Please note: For exterior in-ground applications please use the LD41, LD60, LD43DR, LD56 or LD56T. These have an integral anti-wicking barrier and thicker cable which is more suitable for exterior in-ground installations.

KEY FEATURES

- > High-power C1 engine with NICHIA LED delivering up to 174lm
- > Miniature fitting with very minimal body depth and bezel diameter
- > Uplight version of our LD42 wall light with a flush glass in-ground walk over bezel
- > Options include 50% glare shield (LD43W), combined 50% glare shield and 20° tilt film (LD43A), 70% glare shield (LD43R) or combined 70% glare shield and 20° tilt film (LD43AR)
- > Wide range of high-quality machined metal and painted bezel finishes available, including: 316 Stainless Steel, Polished & Passivated 316 Stainless Steel, Brass, Flamed Solid Bronze, White (RAL 9016), Black (RAL 9005), Classic Bronze (YM262E), Gunmetal Grey (RAL 7021) and any RAL
- > High efficiency optics produce excellent beam spread and shape
- > LED recessed 10mm within the body for reduced glare
- > Hidden fixing options include spring clips or /480 first fix sleeve with O-rings
- > Switched, 0-10V, Casambi, DMX, DALI or Mains dimmable drivers available



DIMENSIONS

Dimensions in mm

For fixing and accessory dimensions please go to page 4.



WHITE LED ENGINE SPECIFICATION

Engine	 C1	
Beam angles	12°, 31°, 48°, 12° x 36°	
LED manufacturer	NICHIA	
Colour temperature	2200K / 2700K / 3000K / 4000K / 5000K	
Current	350mA	500mA
LED power (Max)**	1.2W	1.7W
Delivered lumens (L ₁₀₀)*	103	134
Lumens per circuit watt	86	79
Forward voltage (V ₁₀₀)	3V	3.2V
CRI (Typ)	93	93
Colour consistency	2 SCDM	
Peak intensity	1057 cd	
LED Lumens	206	
LOR	0.84	
TM30	RF93	RG100
UGR***	18.3	
LED lifetime	L90B5 at 90,000hrs	
Applications		

This data is based on LD43-C1-500-LW30-NB

*Lumen output data applies to all colour temperatures

** Indicates the nominal power for the LED run at that particular current and includes losses associated with using an 85% efficient driver

***UGR values based on room parameters of 4H 8H, C70 W50 F20

LD43A and LD43W lumen output will be 40% less due to the glare shield - LD43R lumen output will be 77% less - LD43AR lumen output will be 73% less

MECHANICAL

Ambient temperature	-20° to 45° (350mA) or -20° to 35° (500mA)
Glass	3.3mm thick borosilicate
Materials	Hard anodised aluminium body with machined 316 stainless steel bezel
IP rating	IP66
Wiring	In-series constant current wiring (pre-wired with 2 x single core cable at a length of 150mm)

AVAILABLE FINISHES

Please refer to our finishes guide for full details



316 STAINLESS STEEL

- > Marine grade 316 Steel
- > Standard machined finish
- > Extremely durable
- > Passivation recommended for marine environments to prevent corrosion and build up of brown stains caused by oxidation
- > Interior & exterior use



POLISHED & PASSIVATED 316 STAINLESS STEEL

- > Marine Grade 316 Steel
- > Mirror like finish
- > Extremely durable
- > Passivated to extensively prolong resistance to corrosion and brown stains caused by oxidation in marine environments
- > Interior & exterior use



MACHINED BRASS

- > Solid CZ121 Brass
- > Standard machined finish
- > Corrosion resistance rated fair to excellent
- > Please note a natural green/brown patination layer will form after long term exposure to the elements, the extent of this discolouration will be dependant on its location.
- > Interior & exterior use



FLAMED SOLID BRONZE

- > Solid Bronze
- > Hand finished Flamed Bronze unique to LightGraphix
- > Extremely durable with very high corrosion resistance
- > Please note a natural dark patination layer will form after long term exposure to the elements, the extent of this discolouration will be dependant on its location.
- > Interior & exterior use



PAINT FINISH - POWDER COAT

- > White (RAL 9016), Black (RAL 9005), Classic Bronze (YM262E), Gunmetal Grey (RAL 7021) and other RAL colours available
- > Smooth matt texture unless stated otherwise
- > Not recommended for footlights in high traffic areas
- > Interior & exterior use

DIMENSIONS AND FIXING ACCESSORIES

Dimensions in mm

/480 O-rings and sleeve

Robust, watertight method of fixing for in-ground applications.

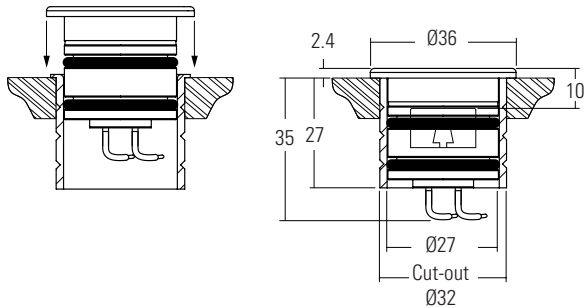

/SC Spring clip fixing

Provide a simple single-fix mounting method.

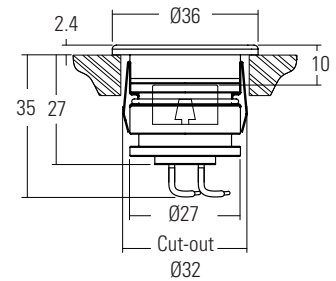

Design: Design Plus Light Project: Cutters Wharf Product: LD43

GLARE CONTROL AND LIGHT OUTPUT OPTIONS

LD43

Circular aperture with lens and LED assembly recessed into the body by 10mm.

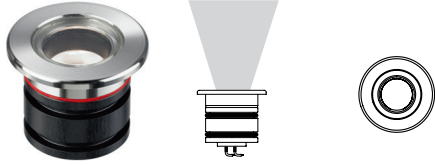

LD43W

Addition of a half-moon glare shield in front of the lens to further reduce glare. Please note that the oval beam cannot be used with the LD43W.

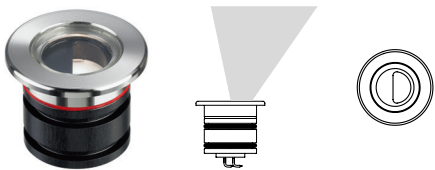

LD43A

Features the LD43W half-moon glare shield, but with the addition of an integral 20° tilt film which angles the light towards the lit surface. Please note that the oval beam cannot be used with the LD43A.

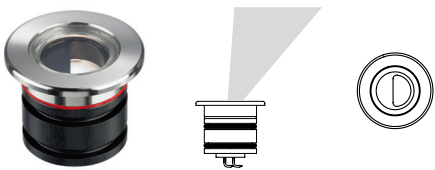

LD43R

Features a 70% glare shield for applications that require minimal output and glare. Please note that the oval beam cannot be used with the LD43R.

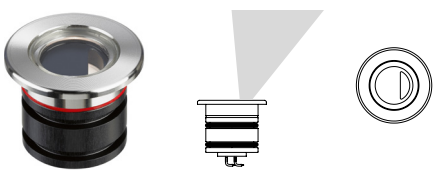

LD43AR

Features the LD43R 70% glare shield, but with the addition of an integral 20° tilt film which angles the light towards the lit surface. Please note the LD43AR is only available in a narrow beam.

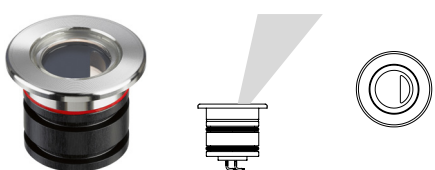

LD43W
Project: Harrods - Super Brands
Design: Lighting Design International

ORDER CODES & OPTIONS

Example: LD43A-C1-500 / LW30 / MB / 316 Stainless Steel / 480

Light Engine & Drive Current

LED Colour

Beam Angle

Finish

Fixing & Accessories

LD43 - / / / /

WHITE LED ENGINES

 C1

LD43	
1.2W LED at 350mA	LD43-C1-350
1.7W LED at 500mA	LD43-C1-500

LD43W / LD43A / LD43R	
1.2W LED at 350mA	LD43W-C1-350 LD43A-C1-350 LD43R-C1-350
1.7W LED at 500mA	LD43W-C1-500 LD43A-C1-500 LD43R-C1-500

LD43AR	
1.2W LED at 350mA	LD43AR-C1-350
1.7W LED at 500mA	LD43AR-C1-500

Super Warm White (2200K)	/LW22
Extra Warm White (2700K)	/LW27
Warm White (3000K)	/LW30
White (4000K) - on request	/LW40
Cool White (5000K)	/LW50
Red	/LR
Green	/LG
Blue	/LB
Amber	/LA

12° Narrow spot	/NB
31° Medium	/MB
48° Wide	/WB
12° x 36° Oval	/OB

12° Narrow spot	/NB
31° Medium	/MB
48° Wide	/WB

12° Narrow spot	/NB
-----------------	-----

	316 Stainless Steel
	Polished & Passivated 316 Stainless Steel (for marine environments)
	Machined Brass
	Flamed Solid Bronze
	Paint Finish - Black (RAL 9005)
	Paint Finish - Classic Bronze (YM262E)
	Paint Finish - Gunmetal Grey (RAL 7021)
	Paint Finish - White (RAL 9016)
	Paint Finish - RAL

	/480
	/SC

Drivers

Use with 350mA & 500mA constant current LED drivers

We have a range of dimmable LED drivers including DMX and DALI compatible. Please see the downloads section on our website.