

LD780

FIXED COMPACT INTERIOR/EXTERIOR LED DOWNLIGHT

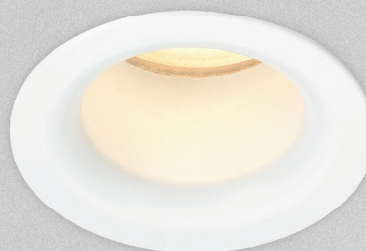

The compact LD780 has an excellent size to output ratio that is ideal for general downlighting and the highlighting of walls and columns within interior, exterior and marine applications. With a diameter of just 46mm, the aluminium bezel can be specified in a wide range of paint finishes and features a deep recessed optic within the body to ensure ultimate low glare. Available LED engines include E2 and F1, offering colour temperatures of 2200K-5000K and a variety of beam angles, including a super tight 10° narrow beam with medium options for more general downlighting. Though compact, the LD780 provides brilliant thermal and light output performance, with a single optic generating a superior beam shape and no multiple shadows.



KEY FEATURES

- > Very low glare with deep recessed optic set back 25mm
- > Single optic for superior beam shapes with no multiple shadows
- > Compact powerful fitting delivering over 400lm in 3000K
- > Super tight 10° narrow spot beam available
- > Machined aluminium bezel available in a wide range of finishes; White (RAL 9016), Black (RAL 9005), Silver, Antique Bronze, Satin Antique Brass, Satin Brass, Anthracite Grey (RAL 7016) or any RAL paint finish
- > Versatile fitting rated IP65, ideal for interior and exterior projects including marine, hospitality and residential general downlighting, column and wall washing
- > Features our E2 & F1 LED engines which are used across our uplight and surface mounted products enabling colour and beam consistency across a project
- > E2 engine features reverse polarity protection
- > F1 COB engine with super warm 2200K option and 90+ CRI
- > Switched, 0-10V, Casambi, DMX, DALI, or Mains dimmable drivers available



DIMENSIONS

Dimensions in mm

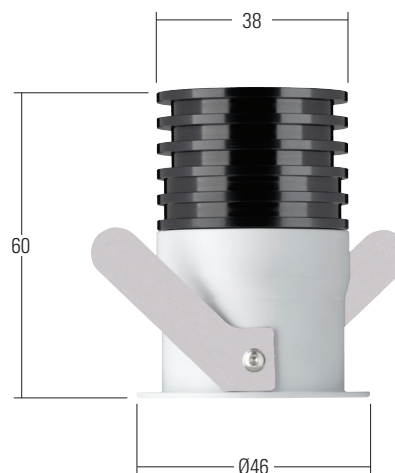
For fitting dimensions please go to page 3.



LED ENGINE SPECIFICATION

Engine	 E2		 F1		
Beam angles	10°, 26°		21°, 28°		
LED manufacturer	CREE		CREE		
Colour temperature*	2700K / 3000K / 4000K / 5000K		2200K / 2700K / 3000K / 4000K / 5000K		
Current	350mA	500mA	350mA	500mA	700mA
LED power (Max)	4.2W (5W**)	6W (7W**)	3.2W (3.5W**)	4.5W (5W**)	6.3W (7W**)
Delivered lumens (L ₁₀₀)	332	429	256	330	420
Lumens per circuit watt	79	72	81	73	67
CRI (Min)	85+		90+		
Forward voltage (V ₁₀₀)	14V		9V		
Colour consistency	2 SCDM		3 SCDM		
Peak intensity	6061 cd		2201 cd		
LED lumens (at max output)	574		715		
LOR	0.75		0.54		
TM30	84.8	99.2	90.1	102.2	
UGR***	15.4		18.6		
LED lifetime	L90B5 at 90,000hrs		L80B5 at 80,000hrs		
Applications					

These values are based around a LD780-E2-500-LW30-NB & LD780-F1-700-LW30-MSB

*See lumen variance table to the right

**indicates the nominal power for the LED run at that particular current and includes losses associated with using an 85% efficient driver

*** UGR values based on room parameters of 4H 8H, C70 W50 F20

Lumen variance by CCT	
2700K	+/- 0%
4000K	+7%
5000K	+16%

MECHANICAL

Ambient temperature	-20° to 45° (350mA) or -20° to 35° (500mA)
Glass	Low iron clear glass, 1mm thick
Materials	Aluminium bezel, black anodised aluminium body
Weight of product	0.12kg
IP rating	IP65
Wiring	In-series constant current wiring (pre-wired with 2 core cable at a length of 250mm)

AVAILABLE FINISHES

Please refer to our finishes guide for full details

The LD780 bezel is machined from aluminium and painted in-house at LightGraphix. Wet spray paint finishes are suitable for interior, exterior and high saline marine environments. Our standard colours are below but we can accommodate any RAL request.



WHITE (RAL 9016)



BLACK (RAL 9005)



SILVER ANODISED

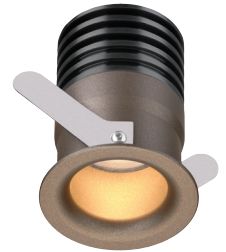

ANTIQUE BRONZE

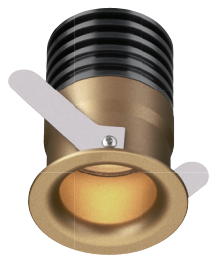

SATIN ANTIQUE BRASS

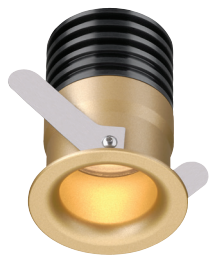

SATIN BRASS



ANTHRACITE GREY (RAL 7016)



RAL

DIMENSIONS & FIXING OPTIONS

Dimensions in mm

2 x spring clips are supplied as standard and provide a simple single-fix mounting method. Suitable for use in surfaces with a thickness of 1mm – 25mm.

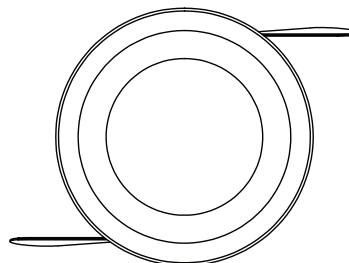
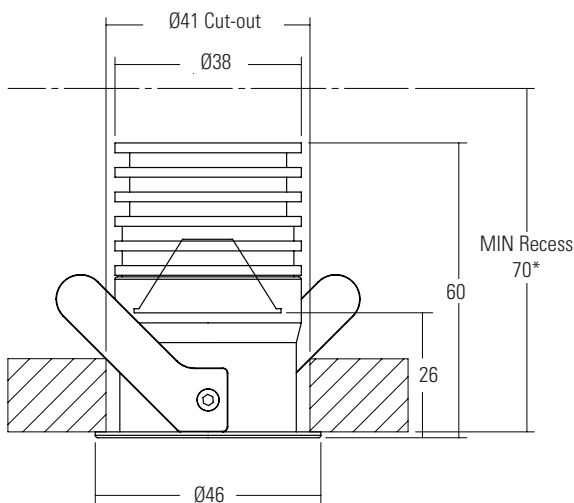

*see ceiling requirements table for more information

CONE DIAGRAMS

E2 LED Engine

Cone diagrams below are based on a 3000K E2 LED engine run at maximum output 500mA, 7W. Images below represent beam outputs when wall washing a 3m wall, spaced 125mm away from the lit surface. Photometric files (LDT) are included in the design pack which can be downloaded from the LD780 product page on the website.

Narrow Spot Beam 500mA using a 10° optic

Distance (m)	Luminance (lx)
0.5	0.11 00
1.0	0.21 00
1.5	0.32 00
2.0	0.42 00
2.5	0.53 00
3.0	0.63 00

Cone Width (m)

Medium Beam 500mA using a 26° optic

Distance (m)	Luminance (lx)
0.5	0.24 00
1.0	0.48 00
1.5	0.71 00
2.0	0.95 00
2.5	1.19 00
3.0	1.43 00

Cone Width (m)

F1 LED Engine

Cone diagrams below are based on a 3000K F1 LED engine run at maximum output 700mA, 7W. Images below represent beam outputs when wall washing a 3m wall, spaced 125mm away from the lit surface. Photometric files (LDT) are included in the design pack which can be downloaded from the LD780 product page on the website.

Medium Spot Beam 700mA using a 21° optic

Distance (m)	Luminance (lx)
0.5	0.19 00
1.0	0.38 00
1.5	0.57 00
2.0	0.76 00
2.5	0.94 00
3.0	1.13 00

Cone Width (m)

Medium Beam 700mA using a 28° optic

Distance (m)	Luminance (lx)
0.5	0.25 00
1.0	0.51 00
1.5	0.76 00
2.0	1.01 00
2.5	1.27 00
3.0	1.52 00

Cone Width (m)

CEILING VOID REQUIREMENTS

Installation requirements can vary but the minimum installation volume requirements must be adhered to. The volume of air within the void ensures that the thermal performance of the product is not compromised and that proper cooling of the LED can take place. The minimum void height is 70mm.

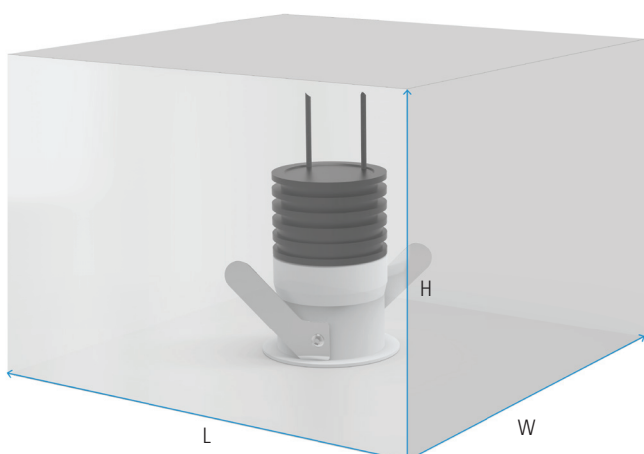

E2 LED			
Output current	Minimum void dimension requirements (Lmm x Wmm x Hmm)	Minimum void volume	
		cm ³	Litre(s)
LD780-E2-350	120 x 120 x 70	1008cm ³	1
LD780-E2-500	200 x 200 x 70	2800cm ³	2.8

F1 LED			
Output current	Minimum void dimension requirements (Lmm x Wmm x Hmm)	Minimum void volume	
		cm ³	Litre(s)
LD780-F1-350	120 x 120 x 70	1008cm ³	1
LD780-F1-500	140 x 140 x 70	1372cm ³	1.3
LD780-F1-700	200 x 200 x 70	2800cm ³	2.8

ORDER CODES & OPTIONS

Example: LD780-E2-500 / LW30 / NB / WHITE









Light Engine & Drive Current	/	LED Colour	/	Beam Angle	/	Finish
LD780 -	/		/		/	

 E2

5W LED at 350mA	LD780-E2-350
7W LED at 500mA	LD780-E2-500

Extra Warm White (2700K)	/LW27
Warm White (3000K)	/LW30
White (4000K) - on request	/LW40
Cool White (5000K)	/LW50

10° Narrow spot	/NB
26° Medium	/MB

	White (RAL 9016)
	Black (RAL 9005)
	Silver Anodised
	Antique Bronze
	Satin Antique Brass
	Satin Brass
	Anthracite Grey (RAL 7016)
	RAL

 F1

3.5W LED at 350mA	LD780-F1-350
5W LED at 500mA	LD780-F1-500
7W LED at 700mA	LD780-F1-700

Super Warm White (2200K)	/LW22
Extra Warm White (2700K)	/LW27
Warm White (3000K)	/LW30
White (4000K) - on request	/LW40
Cool White (5000K)	/LW50

21° Medium spot	/MSB
28° Medium	/MB

Drivers
Use with 350mA, 500mA & 700mA constant current LED drivers
We have a wide range of LED drivers available. Please see the downloads section of our website.